

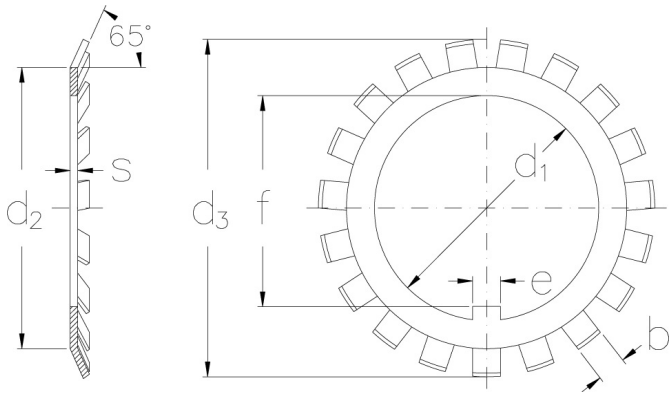

MB 15

Sicherungsbleche, metrische Abmessung



Technische Daten

d1 (mm)	75
d2 (mm)	90
d3 (mm)	104
s (mm)	1,5
e (mm)	8
b (mm)	8
f (mm)	71,5
Gewicht (kg)	0,036

GTIN/EAN



Passende Teile zu diesem Produkt

KM 15
Muttern mit metrischem Gewinde